

CONECTO SINUS
06NC85-5D-T8 h=155
Przekrój

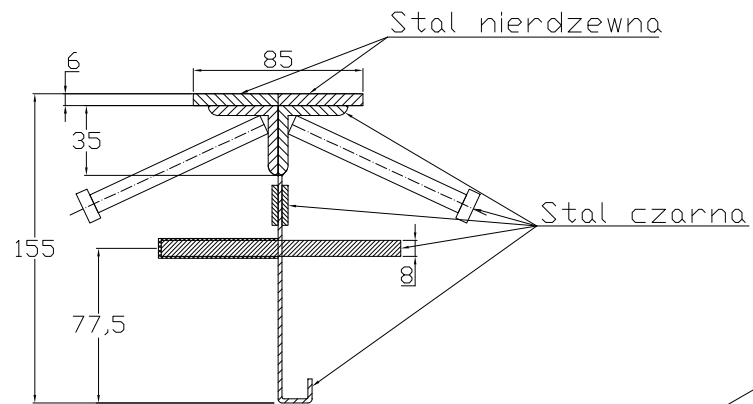

CONECTO SINUS
06NC85-5D-T8 h=155
Rzut aksonometryczny

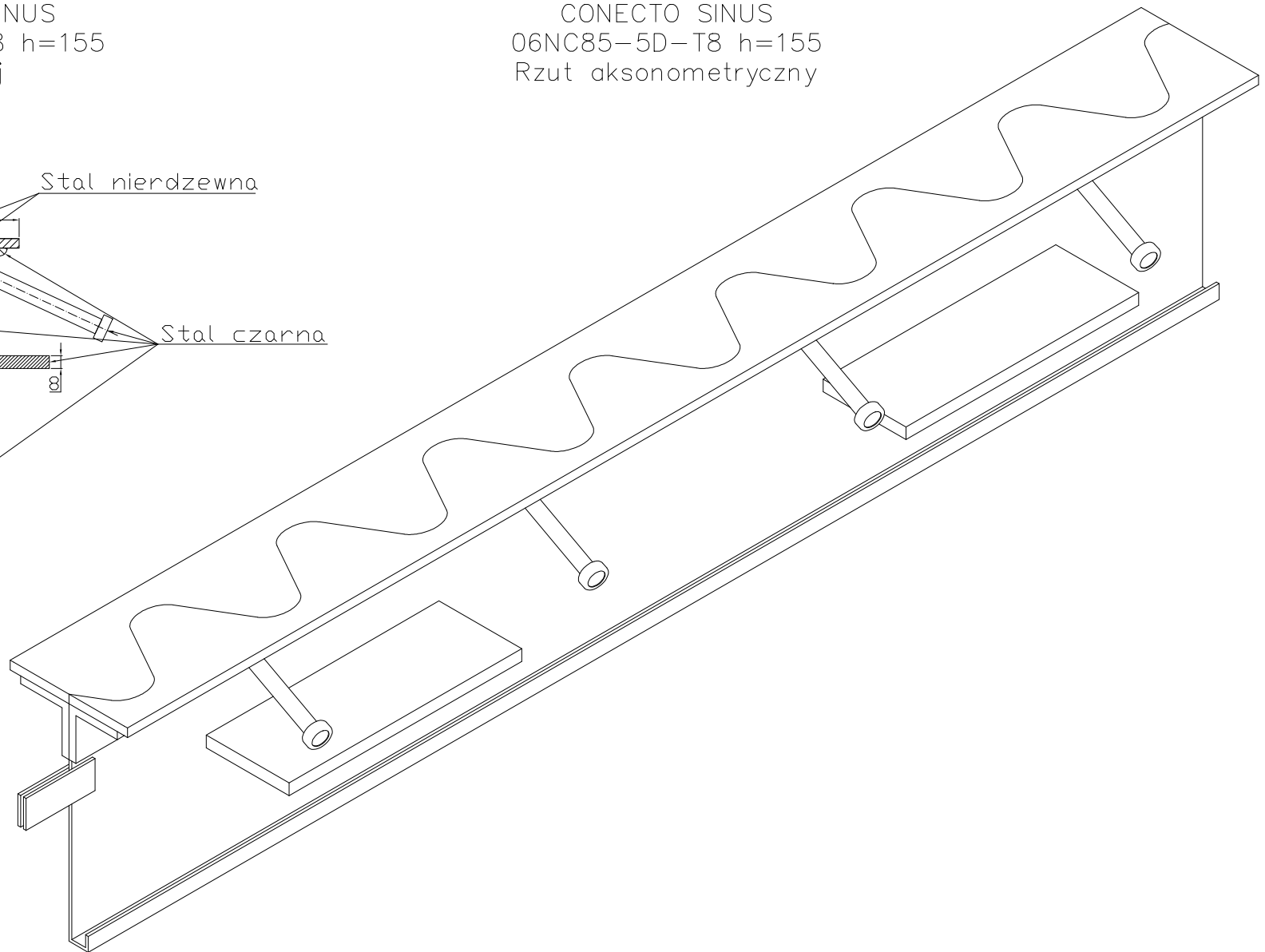

Profil dylatacyjny Conecto Sinus
06NC85-5D-T8 h=155
L=3000, Stal nierdzewna

Conecto Profiles Sp. z o.o.
ul. Przemysłowa 39
61-541 Poznań
www.conecto-profiles.com



ROZMIAR / SIZE A3	SKALA / SCALE 1:1	Wszystkie wymiary podano w [mm] All dimensions in [mm]
----------------------	----------------------	---

PROJEKT	PROJECT	ZŁOŻENIE	SUB ASSEMBLY	RYSUNEK	DRAWING	ARKUSZ	SHEET	WER	REV
--		--		01		1	Z OF	1	